

INFRARED LASER DIODE

DL-4140-001S

SANYO

Ver.1.00 Jun. 2001

Features

- Wavelength : 785 nm (Typ.)
- Low threshold current : $I_{th} = 30$ mA (Typ.)
- Small package : $\phi 5.6$ mm

Applications

Laser Beam printer

Absolute Maximum Ratings

($T_c=25^\circ\text{C}$)

Parameter		Symbol	Ratings	Unit
Light Output	CW	P_o	25	mW
Reverse Voltage	Laser	VR	2	V
	PIN		30	
Operating Temperature		T_{opr}	-10 to +60	$^\circ\text{C}$
Storage Temperature		T_{stg}	-20 to +85	$^\circ\text{C}$

Electrical and Optical Characteristics 2) 3) 4) 6)

Parameter		Symbol	Condition	Min.	Typ.	Max.	Unit
Threshold Current		I_{th}	CW	-	30	50	mA
Operating Current		I_{op}	$P_o=20\text{mW}$	-	65	90	mA
Lasing Wavelength		L_p	$P_o=20\text{mW}$	776	785	800	nm
Beam ¹⁾ Divergence	Perpendicular	Q_v	$P_o=20\text{mW}$	15	25	35	$^\circ$
	Parallel	Q_h	$P_o=20\text{mW}$	7	9	12	$^\circ$
Off Axis Angle	Perpendicular	dQ_v	$P_o=20\text{mW}$	-	-	± 3	$^\circ$
	Parallel	dQ_h	$P_o=20\text{mW}$	-	-	± 2	$^\circ$
Differential Efficiency		dP_o/dI_{op}	-	0.3	0.6	0.8	mW/mA
Monitoring Output Current		I_m	$P_o=20\text{mW}$	0.3	0.8	1.5	mA
Astigmatism		A_s	$P_o=20\text{mW}$	-	-	10	μm
Droop		d_p	$P_o=20\text{mW}$	-	-	10	%

1) Full angle at half maximum

Note : The above product specification are subject to change without notice.

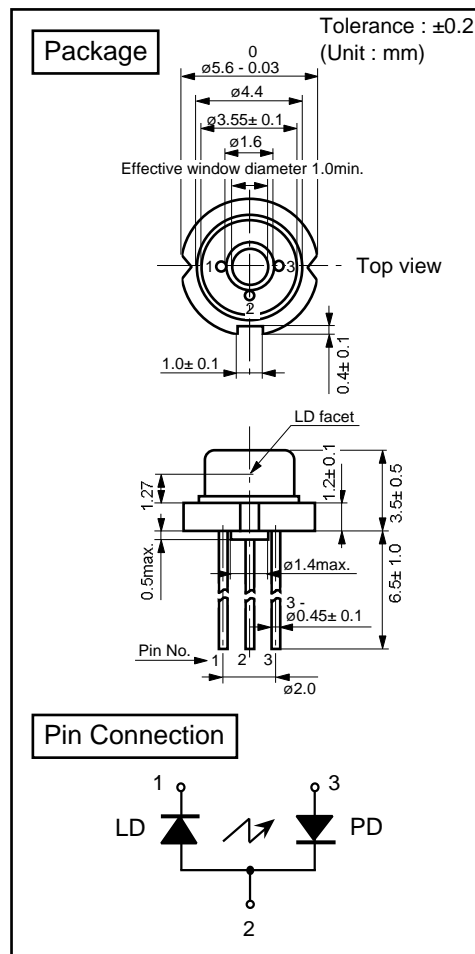

($T_c=25^\circ\text{C}$)

Tottori SANYO Electric Co., Ltd. Electronic Device Business Headquarters
LED Division

5-318, Tachikawa, Tottori 680-8634 Japan

TEL : +81-857-21-2137 FAX : +81-857-21-2161

Characteristics

Output Power vs. Forward current

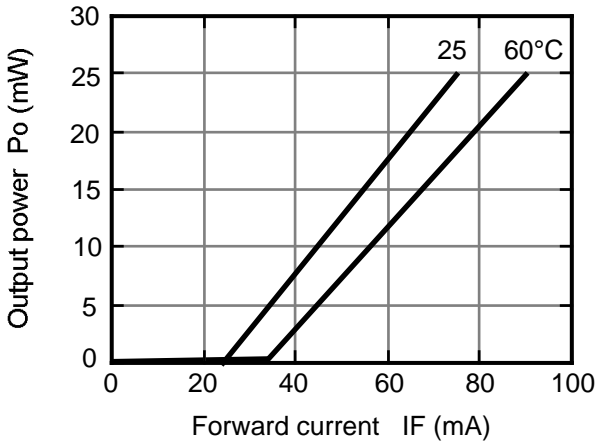

Threshold current vs. Temperature

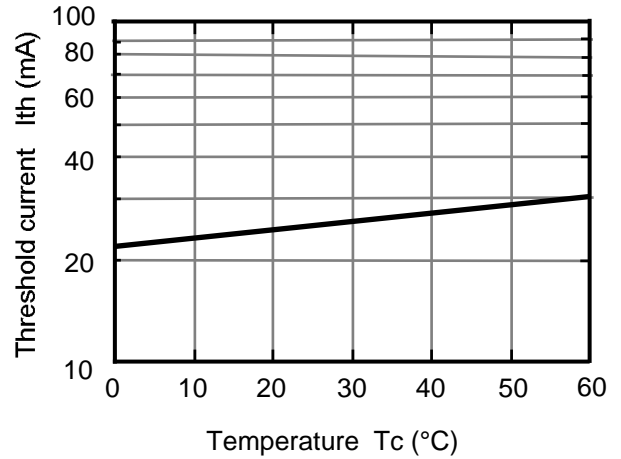

Monitor current vs. Output power

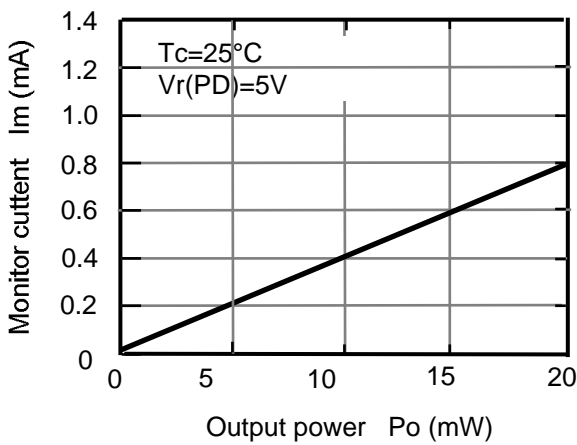

Beam divergence

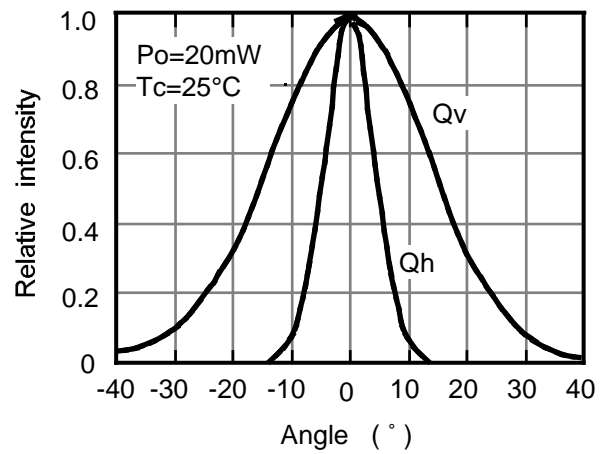

Lasing wavelength vs. Temperature

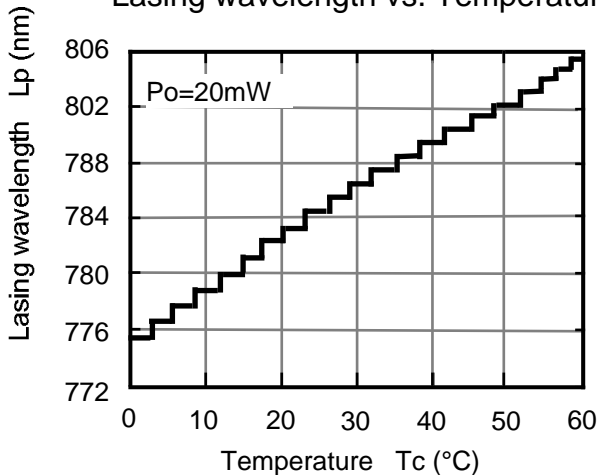

Lasing wavelength vs. Output power

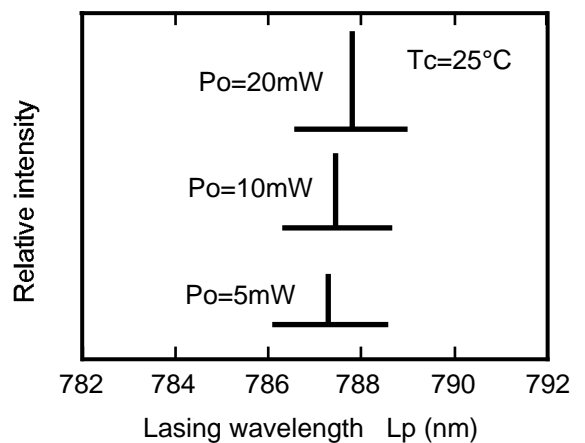

This is typical data and it may not represent all products.