

RED LASER DIODE

DL-6147-040

SANYO

Ver.2 .May. 2005

Features

- Short wavelength : 658 nm (Typ.)
- High output power : 40 mW at 60°C (CW)
- Low threshold current : I_{th} = 30 mA (Typ.)
- Package : $\phi 5.6$ mm

Applications

Industrial equipment

Absolute Maximum Ratings

(T_c=25°C)

Parameter		Symbol	Ratings	Unit
Light Output	CW	P _o	45	mW
Reverse Voltage	Laser	V _R	2	V
	PD		30	
Operating Temperature		T _{opr}	-10 to +60	°C
Storage Temperature		T _{stg}	-40 to +85	°C

Electrical and Optical Characteristics ^{2) 3)}

(T_c=25°C)

Parameter		Symbol	Condition	Min.	Typ.	Max.	Unit
Threshold Current		I _{th}	CW	-	30	50	mA
Operating Current		I _{op}	P _o =40mW	-	65	85	mA
Operating Voltage		V _{op}	P _o =40mW	-	2.4	2.8	V
Lasing Wavelength		L _p	P _o =40mW	650	658	665	nm
Beam ⁴⁾ Divergence	Perpendicular	Q _v	P _o =40mW	12	16	20	°
	Parallel	Q _h	P _o =40mW	7	10	13	°
Off Axis Angle	Perpendicular	dQ _v	-	-3	-	3	°
	Parallel	dQ _h	-	-3	-	3	°
Differential Efficiency		SE	-	-	1.1	-	mW/mA
Monitoring Output Current		I _m	P _o =40mW	0.3	0.5	0.7	mA

2) Initial values 3) All the above values are evaluated with Tottori Sanyo's measuring apparatus

4) Full angle at half maximum

Note : The above product specification are subject to change without notice.

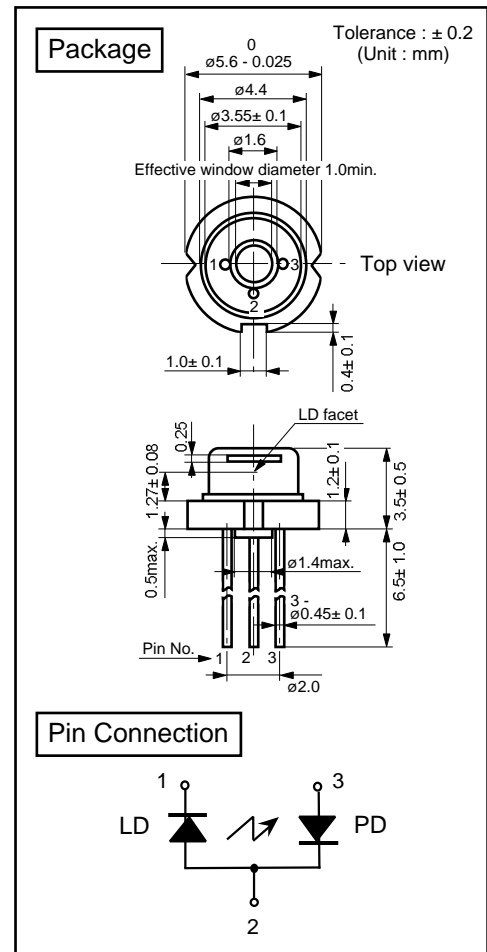

Characteristics

Output power vs. Forward current

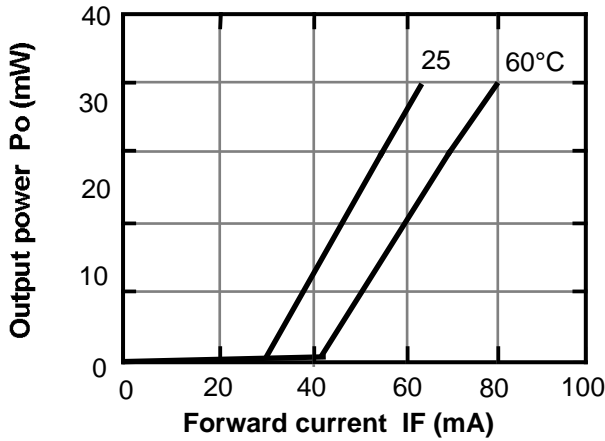

Threshold current vs. Temperature

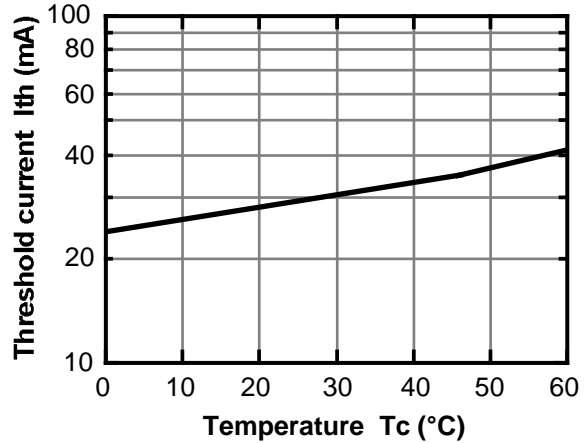

Monitoring current vs. Output power

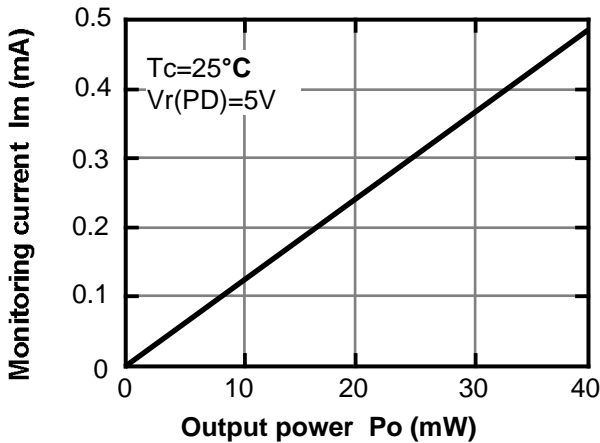

Beam divergence

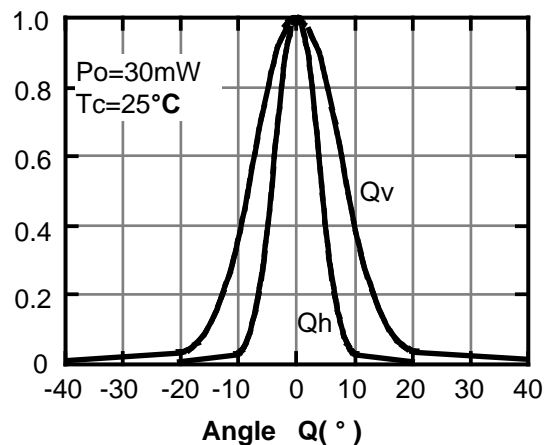

Lasing wavelength vs. Temperature

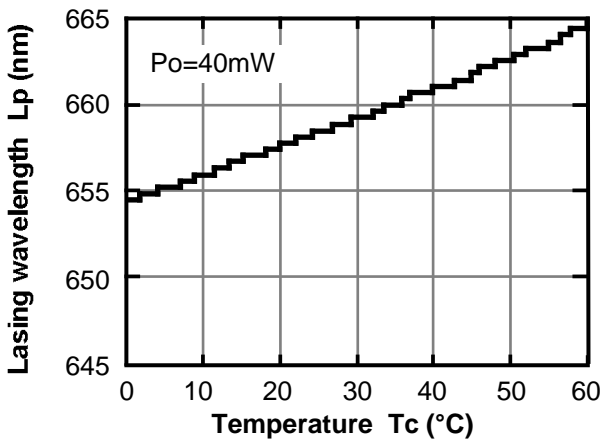

Lasing wavelength vs. Output power

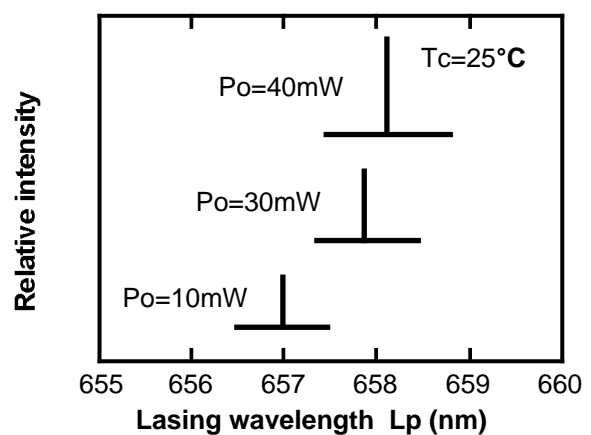

This is typical data and it may not represent all products.