

AlGaAs Infrared Laser Diode

ADL-78901TL

6-2D-LD78-004 Rev.01

★780nm, 90mW Power Reliable Operation

200mW High Power Pulse Reliable Operation

Features

1. Small aspect ratio
2. High COD level

•Applications

1. Virtual keyboard
2. CD R/RW

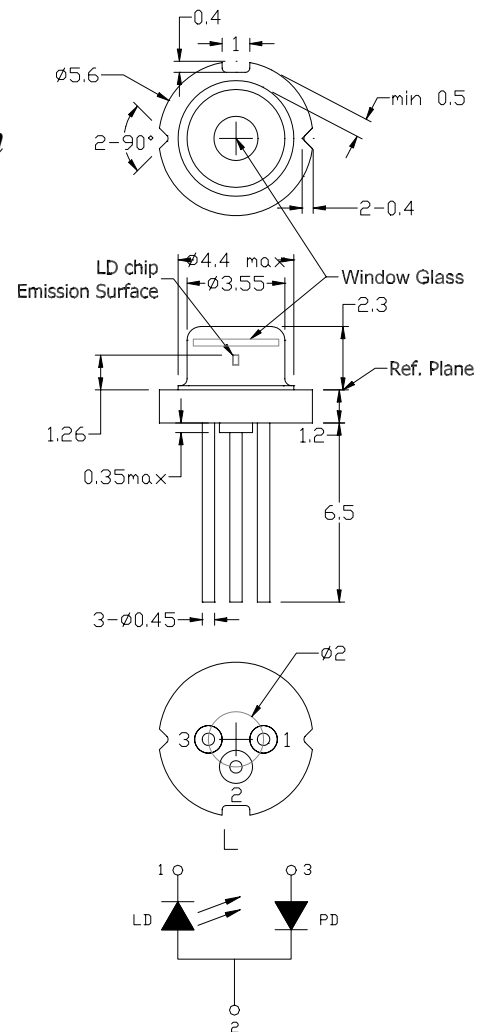

•Absolute maximum ratings

Parameter	Symbol	Condition	Rating	Unit
Light output power	P_o	CW	100	mW
	P_{op}	Pulsed*	220	
Reverse voltage(LD)	V_{RL}	-	2	V
Case temperature	T_c	-	-10~+70	°C
Storage temperature	T_s	-	-40~+85	°C

* Pulse width 0.5us, duty cycle 50%

•Electrical and optical characteristics ($T_c=25^\circ\text{C}$)

Parameter	Symbol	Min.	Typ.	Max.	Unit	Conditions (CW)
Peak wavelength	λ	775	785	795	nm	$P_o=90\text{mW}$
Threshold current	I_{th}	25	35	55	mA	$P_o:1-10\text{mW}$
Operating current	I_{op}	90	115	160	mA	$P_o=90\text{mW}$
Operating voltage	V_{op}	1.5	2	2.2	V	$P_o=90\text{mW}$
Monitor Current	I_m	0.1	0.3	0.7	mA	$P_o=90\text{mW}$, $V_r=5\text{V}$
Differential efficiency	η	0.8	1.1	1.3	mW/mA	$P_o=80-90\text{mW}$
Parallel divergence angle	$\theta_{ }$	7.5	9	10	deg	$P_o=90\text{mW}$
Perpendicular divergence angle	θ_{\perp}	15	17	19	deg	
Parallel FFP deviation angle	$\Delta\theta_{ }$	-2	0	+2	deg	
Perpendicular FFP deviation angle	$\Delta\theta_{\perp}$	-2	0	+2	deg	
Emission point accuracy	$\Delta x \Delta y \Delta z$	-80	0	+80	um	

• Precautions

- * Do not operate the device above maximum ratings. Doing so may cause unexpected and permanent damage to the device.
- * Take precautions to avoid electrostatic discharge and/or momentary power spikes. A change in the characteristics of the laser or premature failure may result.
- * Proper heat sinking of the device assures stability and lifetime. Always ensure that maximum operating temperatures are not exceeded.
- * Observing visible or invisible laser beams with the human eye directly, or indirectly, can cause permanent damage. Use a camera to observe the laser.
- * No laser device should be used in any application or situation where life or property is at risk in event of device failure.
- * Specifications are subject to change without notice. Ensure that you have the latest specification by contacting us prior to purchase or use of the product

* For reference only. Contents above are subject to change without notice.

Arima
LASERS

AlGaAs Infrared Laser Diode

ADL-78901TL

6-2D-LD78-004 Rev.01

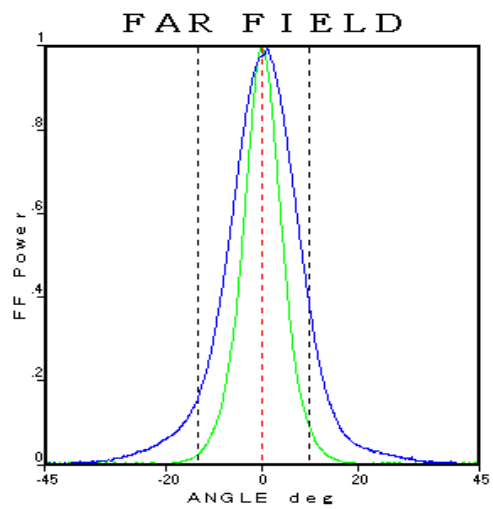
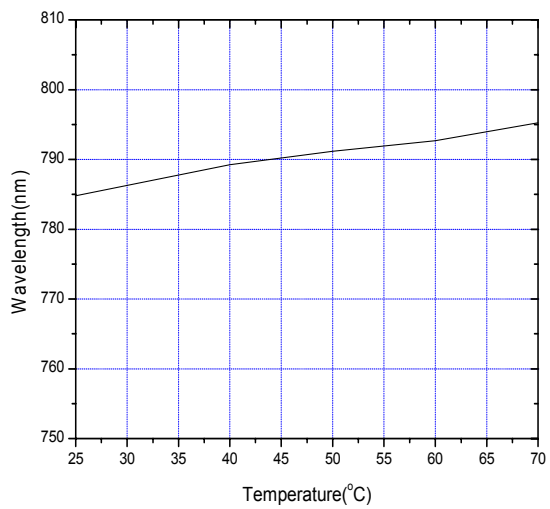
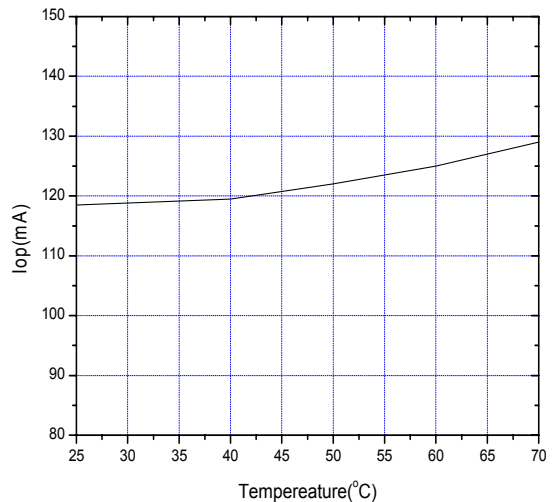
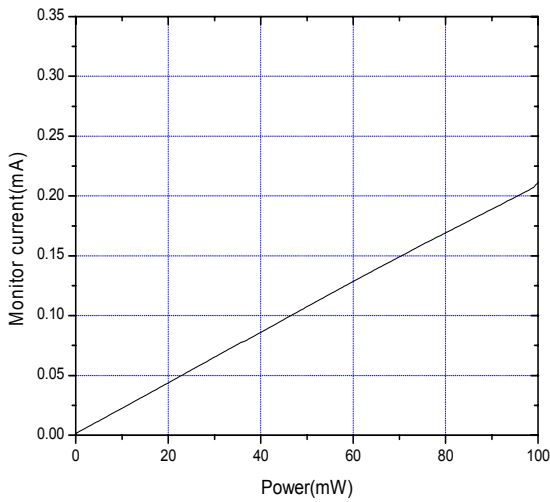
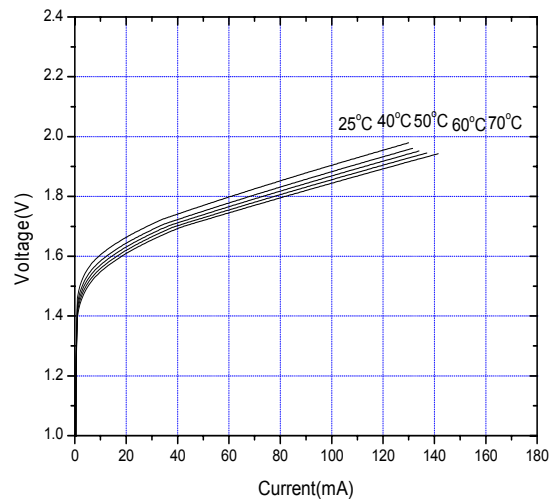
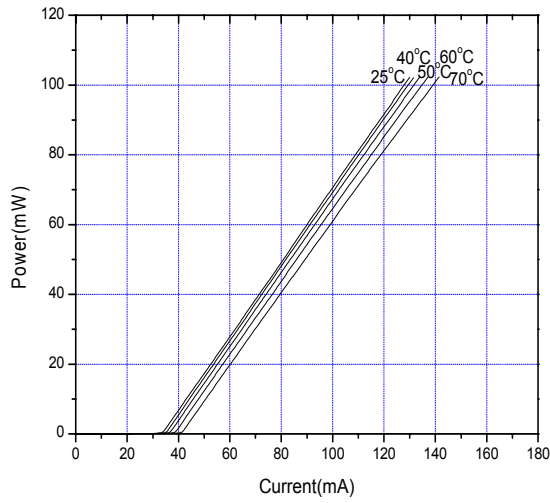

* For reference only. Contents above are subject to change without notice.