

NICHIA

Ultra Violet Laser Diode

NDU4116

■ Features

- Optical Output Power: **CW 70mW (@Tc=25°C)**
- Peak Wavelength: 370~380nm
- Can Type: $\phi 5.6$ Floating Mounted with Photo Diode and Zener Diode

■ Absolute Maximum Ratings

Item	Symbol	Absolute Maximum Ratings	Unit
Optical Output Power (Tc=25°C)*	Po	85	mW
Allowable Reverse Current	Ir (LD)	85	mA
PD Reverse Voltage	Vr (PD)	5	V
Storage Temperature	Tstg	-40 ~ 85	°C
Operating Case Temperature	Tc	10 ~ 40	°C

■ Initial Electrical/Optical Characteristics

(Tc=25°C)

Item	Condition	Symbol	Min	Typ.	Max	Unit	
Optical Output Power*	CW	Po	-	-	70	mW	
Peak Wavelength	Po=70mW	λ_p	370	-	380	nm	
Threshold Current	CW	Ith	30	50	75	mA	
Operating Current	Po=70mW	Iop	80	110	140	mA	
Slope Efficiency	CW	η	0.9	1.2	1.6	W/A	
Operating Voltage	Po=70mW	Vop	4.6	5.4	6.0	V	
Beam Divergence**	Parallel	Po=70mW	$\theta_{//}$	6.0	9.0	11.0	°
	Perpendicular	Po=70mW	θ_{\perp}	19.0	22.5	26.0	°
Beam Pointing Accuracy	Parallel	Po=70mW	$\Delta\theta_{//}$	-3.0	-	3.0	°
	Perpendicular	Po=70mW	$\Delta\theta_{\perp}$	-3.0	-	3.0	°
Monitor Current***	Po=70mW	Im	0.05	0.2	2.0	mA	

* Refer graph of Optical Output Power vs. Case Temperature.

** Full angle at 50% from peak intensity

*** Monitor Current is short time power reference purpose only.
Not guaranteed for accuracy.

All figures in this specification are measured by Nichia's method and may contain measurement deviations.

Outline Dimension

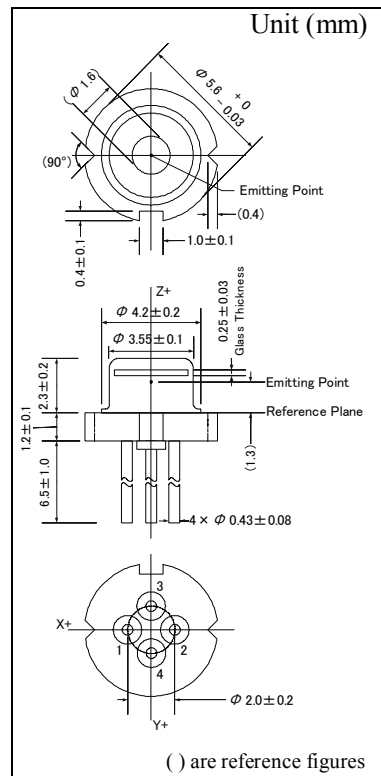

Pin Connection

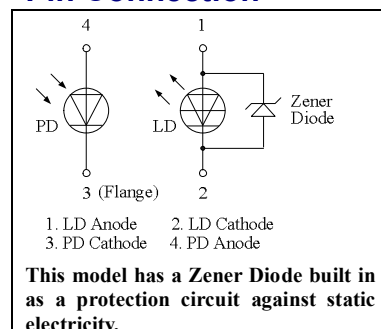

◆ Optical Output Power vs. Case Temperature

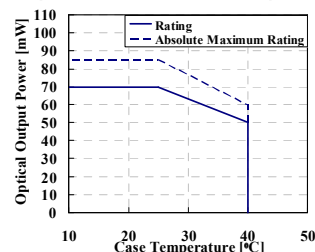

The above specifications are for reference purpose only and subjected to change without prior notice.

NICHIA CORPORATION

<http://www.nichia.co.jp>

◆ HEADQUARTERS

491 Oka, Kaminaka-Cho, Anan-Shi, TOKUSHIMA 774-8601, JAPAN

PHONE: +81-884-22-2311 FAX: +81-884-21-0148

◆ CONTACT

TOKYO SALES OFFICE

13F Tamachi Center Building 34-7, Shiba 5-Chome, Minato-Ku, TOKYO 108-0014, JAPAN

PHONE: +81-3-3456-3108 FAX: +81-3-5440-7330

■ Typical Characteristics

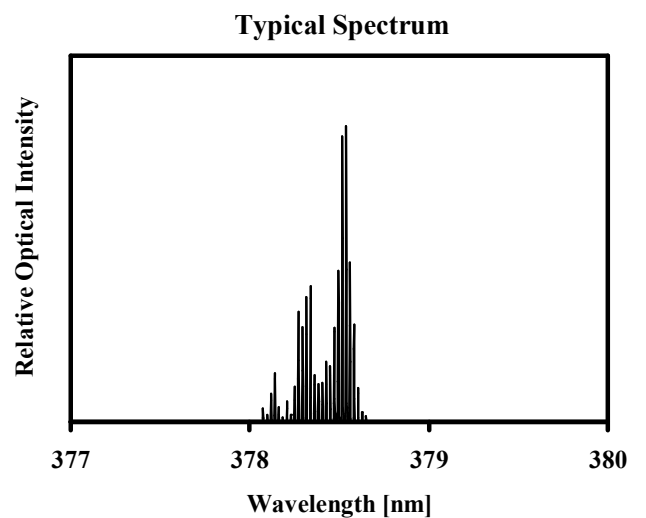
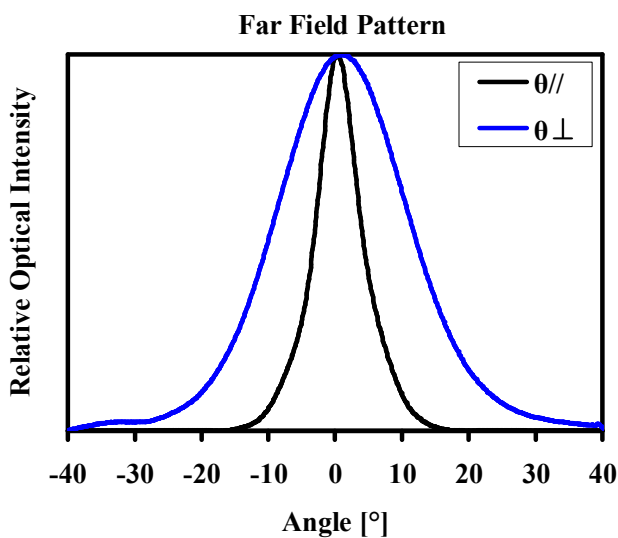
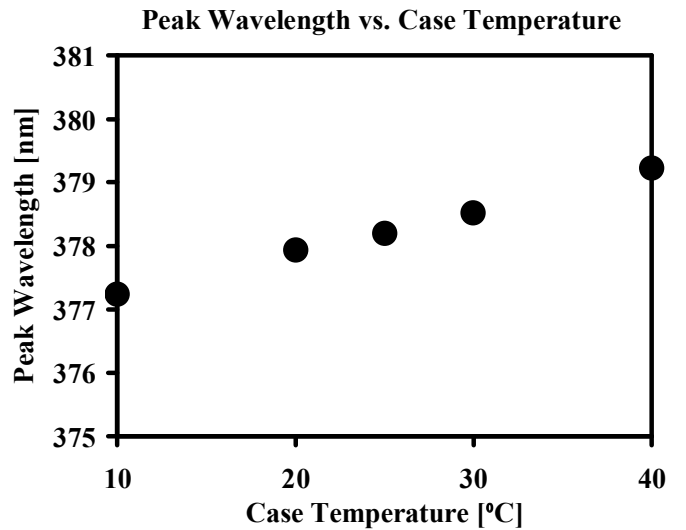
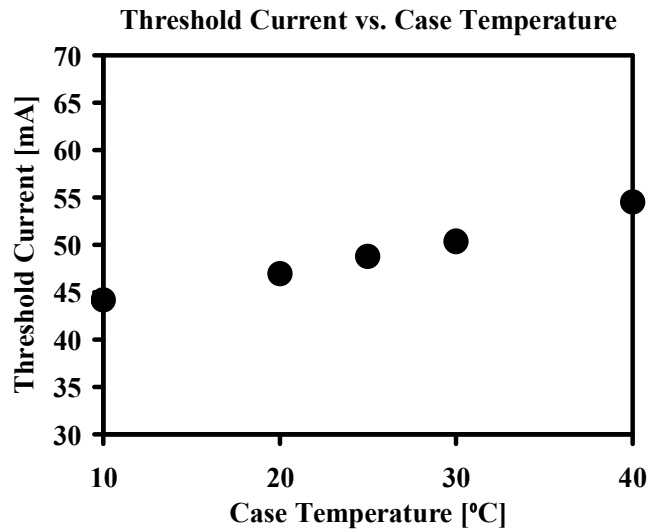
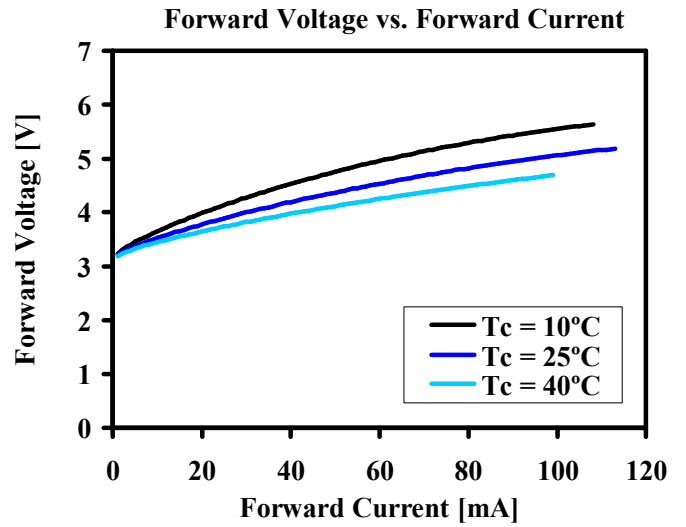
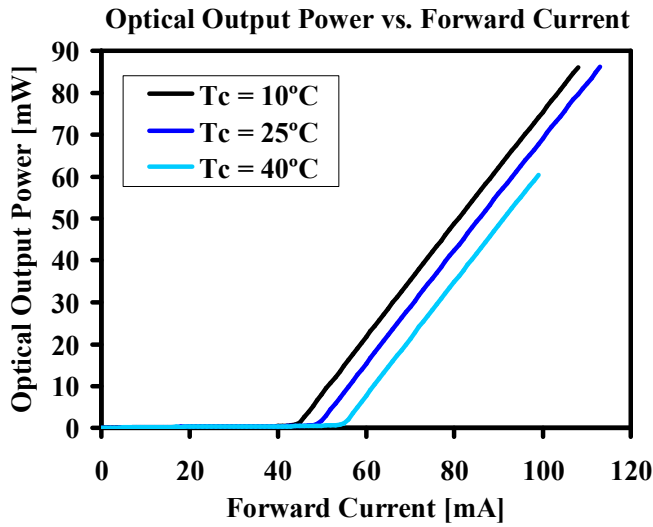

■ Cautions

(1) Safety of Laser light

- **Laser beam are extremely dangerous to human eyes.** Never look at laser beam directly and/or through optical lens. When handling the LDs, wear appropriate safety glasses to prevent laser light, even any reflections from entering to the eye. **Focused laser beam through optical instruments will increase the chance of eye hazard.**
- Nichia LDs are classified in **Class 3B of IEC60825-1 and 21 CFR Part 1040.10 Safety Standards.** It is absolutely necessary to take overall safety measures against User's modules, equipment and systems into which Nichia LDs are incorporated and/or integrated.



(2) Operating method

- The LD shall change its forward voltage requirement and optical output power according to temperature change. Also, the LD will require more operation current to maintain same output power as it degrades.
- Confirm that the optical output power generated by spike current when switching on and off does not exceed the maximum absolute rating. Also, employ appropriate countermeasures to reduce chattering and/or overshooting in the Circuit.

(3) Static Electricity

- Static electricity or electrical surges will reduce and degrade the reliability of the LDs. It is recommended to use a wrist strap or anti-electrostatic glove when handling the Product.

(4) Absolute Maximum Rating

- Active layer of LDs shall have high current density and generate high electric field during its operation. In order to prevent excessive damage, the LD must be operated strictly below Absolute Max Rating.

(5) Others

- Nichia LDs described in this brochure are intended to be used for ordinary electronic equipment (such as office equipment, communications equipment, measurement instruments and household appliances). Consult Nichia's sales staff in advance for information on the applications in which exceptional quality and reliability are required, particularly when the failure or malfunction of the LDs may directly jeopardize life or health (such as for airplanes, aerospace, submersible repeaters, nuclear reactor control systems, automobiles, traffic control equipment, life support systems and safety devices).
- The Purchaser must acknowledge that any LD can statistically fail and must design its equipments in a fail safe design. Prior to use of the LD, please confirm that the LD, as described in Nichia's specifications, meets the life expectancy needs of, and provides the features required by the Circuit and any related modules, equipment and/or systems.
- Due to its short wavelength and high optical output power, optical depositions on optical path may occur depending on surrounding conditions. Appropriate design or countermeasures should be used to avoid optical depositions.
- Nichia prohibits Purchaser from reverse engineering, disassembling, or taking any other steps to derive the structure or design of the LD.
- The appearance and specifications of the product may be modified for improvement without notice. The formal specifications must be exchanged and signed by both parties before large volume purchase begins.
- No unauthorized transmission or reproduction of this document, either in whole or in part, is permitted.
- **This LD contains the one of candidate substance of SVHC (Substance of Very High Concern) specified in REACH (Regulation, Evaluation, Authorization and Restriction of Chemicals) regulation. Nichia reports following information on the basis of Article 33 (Duty to communicate information on substances in articles) in REACH.**

Model number : NDU4116

Affected component : Sealing glass

Substance name : Lead titanium trioxide , CAS number : 12060-00-3

Content : 0.2% to 0.3% per product