

PLPT5 450KA

Metal Can® TO56

Blue Laser Diode in TO56 Package



Applications

- Electronic Equipment
- Projection Home LED & Laser
- Projection Professional LED & Laser

Features:

- Optical power class: 2.2 W pulsed
- Typical emission wavelength: 450 nm
- TO56 package
- High modulation bandwidth
- Single tranverse mode semiconductor laser
- Efficient radiation source for cw and pulsed operation

Ordering Information

Type	Peak output power typ. P_{opt}	Ordering Code
PLPT5 450KA	2.2 W	TBD_PLPT5 450KA

Preliminary datasheet version

Maximum Ratings

$T_c = 25\text{ °C}$

Parameter	Symbol		Values
Operating temperature (T_{case})	T_{op}	min.	-20 °C
		max.	85 °C
Storage temperature	T_{stg}	min.	-20 °C
		max.	120 °C
Junction temperature	T_j	max.	135 °C
Output power	P_{opt}	max.	2.4 W
Operating current ¹⁾	I_{op}	max.	1.8 A
Soldering temperature $t_{\text{max}} = 10\text{ s}$	T_s	max.	260 °C

Operation outside these conditions may damage the device. Operation at maximum ratings may influence lifetime.

Characteristics

$I_F = 1.5 \text{ A}$; $P_{\text{opt}} = 2.2 \text{ W}$; $T_C = 25 \text{ °C}$

Parameter	Symbol		Values
Operating current ¹⁾	I_{op}	typ.	1.5 A
		max.	1.7 A
Center wavelength	λ_{center}	min.	437 nm
		max.	460 nm
Optical output power	P_{opt}	typ.	2.2 W
Optical output power $I_F = 1.1 \text{ A}$	P_{opt}	typ.	1.6 W
Optical output power $I_F = 0.8 \text{ A}$	P_{opt}	typ.	1.0 W
Beam divergence ($1/e^2$) parallel to pn-junction	Θ_{\parallel}	min.	6 °
		typ.	8.5 °
		max.	12 °
Beam divergence ($1/e^2$) perpendicular to pn-junction	Θ_{\perp}	min.	40 °
		typ.	48 °
		max.	55 °
Threshold current	I_{th}	typ.	0.27 A
		max.	0.35 A
Forward voltage ²⁾	V_F	typ.	5 V
Total power dissipation	P_{tot}	typ.	3.7 W
TE polarization	P_{TE}	typ.	100:1
Thermal resistance junction case real	R_{thJC}	typ.	13 K / W

Relative Spectral Emission 3), 4)

$$I_{e,rel} = f(\lambda); I_F = 1.5 \text{ A}; P_{opt} = 2.2 \text{ W}$$

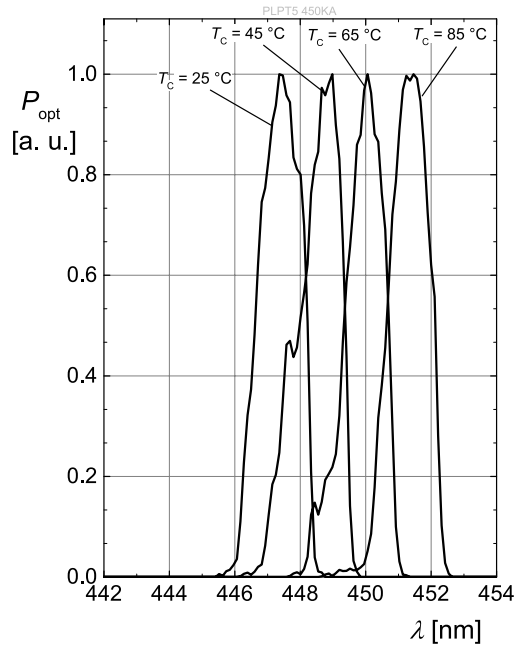

Optical Output Power 3), 4)

$$P_{opt} = f(I_F)$$

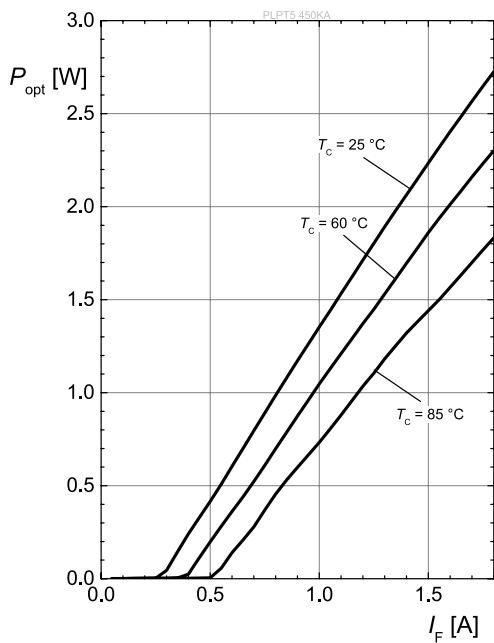

Forward Voltage 3), 4)

$$V_F = f(I_F)$$

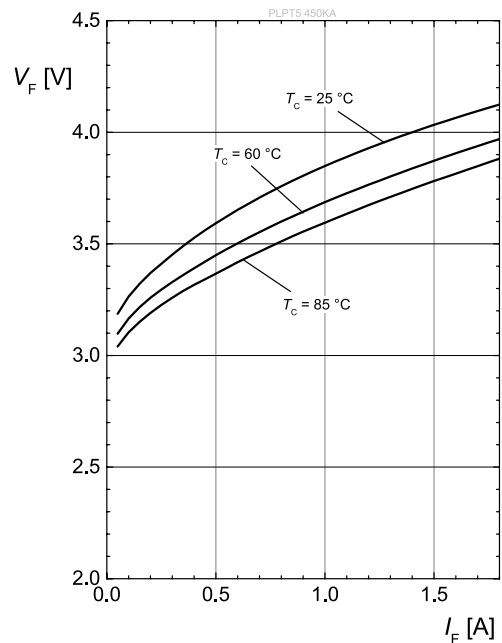

Preliminary datasheet version

Threshold Current

$$I_{th} = f(T_c)$$

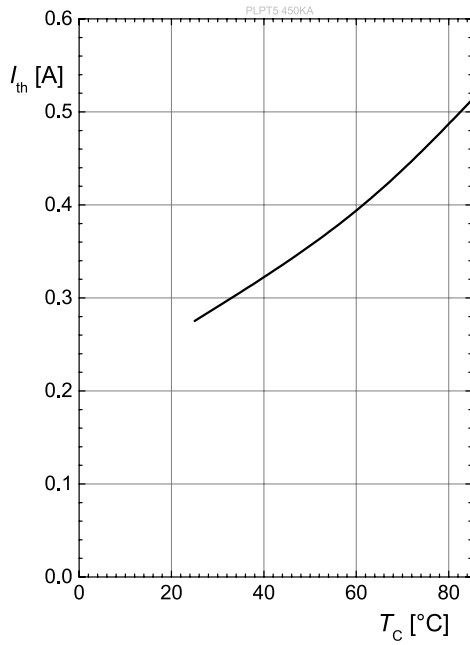

Max. Permissible Opt. Output Power

$$P_{opt} = f(T_c)$$

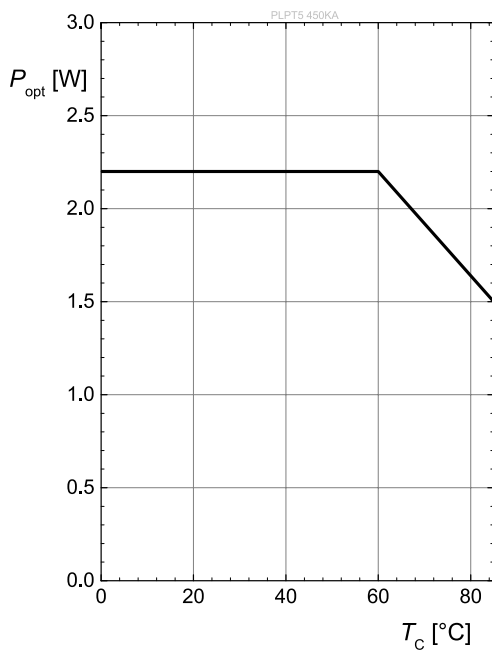

Dimensional Drawing ⁵⁾

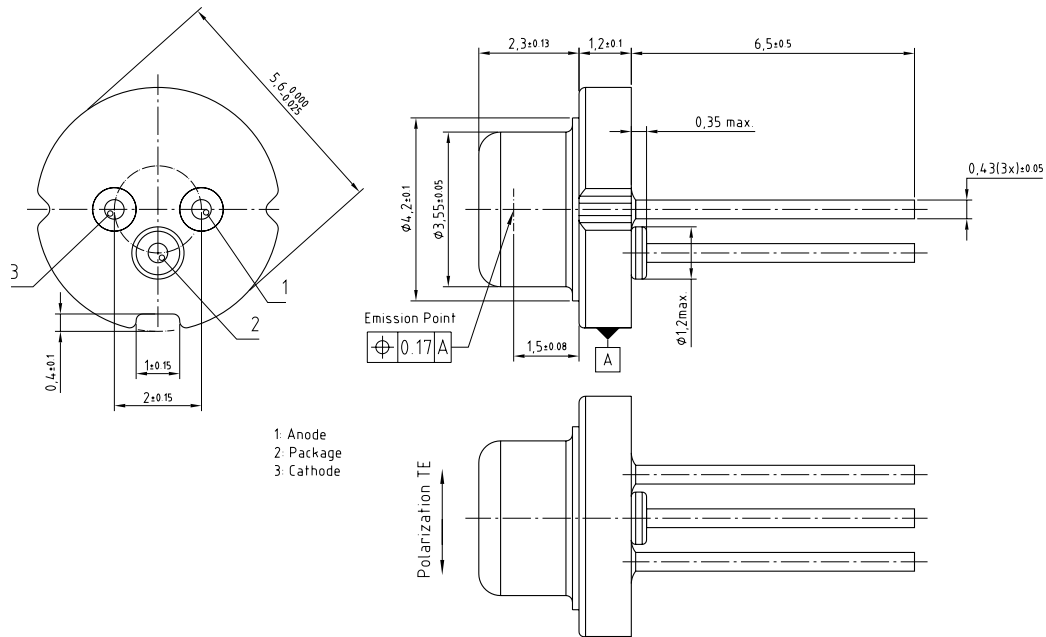

C63062-A4171-A1-04

Further Information

Electrical Internal Circuit

Pin Connection

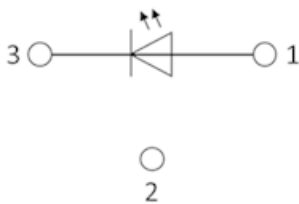

Pin 1: LD Anode
Pin 2: Package
Pin 3: LD Cathode

PLPT5 450KA

Pin	Description
PIN 1	LD Anode
PIN 2	Package
PIN 3	LD Cathode

Notes

Subcomponents of this device contain, in addition to other substances, metal filled materials including silver. Metal filled materials can be affected by environments that contain traces of aggressive substances. Therefore, we recommend that customers minimize device exposure to aggressive substances during storage, production, and use. Devices that showed visible discoloration when tested using the described tests above did show no performance deviations within failure limits during the stated test duration. Respective failure limits are described in the IEC60810.

Handling:

Solvents, water, liquids, non-conductive plastics and glues are not allowed near the device, because solvents and other liquids could emerge and damage the product.

Important notes of operation for laser diode

a) Electrical operation

OSRAMs laser diodes are designed for maximum performance and reliability. Operating the laser diode above the maximum rating even for very short periods of time can damage the laser diode or reduce its lifetime. The laser diode must be operated with a suitable power supply with minimized electrical noise. The laser diode is very sensitive to electrostatic discharge (ESD). Proper precautions must be taken.

b) Mounting instructions

In order to maintain the lifetime of the laser diode proper heat management is essential. Due to the design of the laser diode heat is dissipated only through the base plate of the diode's body. A proper heat conducting interconnection between the diodes base plate and the heat sink must be maintained.

For further application related information please visit www.osram-os.com/appnotes

Disclaimer

OSRAM OS assumes no liability whatsoever for any use of this document or its content by recipient including, but not limited to, for any design in activities based on this preliminary draft version. OSRAM OS may e.g. decide at its sole discretion to stop developing and/or finalising the underlying design at any time.

Attention please!

The information describes the type of component and shall not be considered as assured characteristics. Terms of delivery and rights to change design reserved. Due to technical requirements components may contain dangerous substances.

For information on the types in question please contact our Sales Organization.

If printed or downloaded, please find the latest version on the OSRAM OS website.

Packing

Please use the recycling operators known to you. We can also help you – get in touch with your nearest sales office. By agreement we will take packing material back, if it is sorted. You must bear the costs of transport. For packing material that is returned to us unsorted or which we are not obliged to accept, we shall have to invoice you for any costs incurred

Product and functional safety devices/applications or medical devices/applications

OSRAM OS components are not developed, constructed or tested for the application as safety relevant component or for the application in medical devices.

OSRAM OS products are not qualified at module and system level for such application.

In case Buyer – or Customer supplied by Buyer – considers using OSRAM OS components in product safety devices/applications or medical devices/applications, Buyer and/or Customer has to inform the local sales Partner of OSRAM OS immediately and OSRAM OS and Buyer and /or Customer will analyze and coordinate the customer-specific request between OSRAM OS and Buyer and/or Customer.

Glossary

- 1) **Operating/Forward current:** IF is measured with an internal reproducibility of $\pm 7\%$ (acc. to GUM with a coverage factor of $k = 3$).
- 2) **Operating/Forward voltage:** VF is measured with an internal reproducibility of $\pm 0.05\text{ V}$ (acc. to GUM with a coverage factor of $k = 3$).
- 3) **Typical Values:** Due to the special conditions of the manufacturing processes of semiconductor devices, the typical data or calculated correlations of technical parameters can only reflect statistical figures. These do not necessarily correspond to the actual parameters of each single product, which could differ from the typical data and calculated correlations or the typical characteristic line. If requested, e.g. because of technical improvements, these typ. data will be changed without any further notice.
- 4) **Testing temperature:** TA = 25°C (unless otherwise specified)
- 5) **Tolerance of Measure:** Unless otherwise noted in drawing, tolerances are specified with ± 0.1 and dimensions are specified in mm.

Revision History

Version	Date	Change
0.0	2019-05-23	Features Certificate Logo Product Image Dimensional Drawing

Published by OSRAM Opto Semiconductors GmbH EU RoHS and China RoHS compliant product
Leibnizstraße 4, D-93055 Regensburg
www.osram-os.com © All Rights Reserved.



此产品符合欧盟 RoHS 指令的要求；
按照中国的相关法规和标准，不含有毒有害物质或元素。